

NSK LINEAR GUIDES
NH SERIES, NS SERIES



SUBSCRIBE TO NSK NEWSLETTER 

As one of the world's leading manufacturers of rolling bearings, linear technology components and steering systems, we can be found on almost every continent – with production facilities, sales offices and technology centres – because our customers appreciate short decision-making channels, prompt deliveries and local service.



The NSK company

NSK commenced operations as the first Japanese manufacturer of rolling bearings back in 1916. Ever since, we have been continuously expanding and improving not only our product portfolio but also our range of services for various industrial sectors. In this context, we develop technologies in the fields of rolling bearings, linear systems, components for the automotive industry and mechatronic systems. Our research and production facilities in Europe, Americas and Asia are linked together in a global technology

network. Here we concentrate not only on the development of new technologies, but also on the continuous optimisation of quality – at every process stage.

Among other things, our research activities include product design, simulation applications using a variety of analytical systems and the development of different steels and lubricants for rolling bearings.

Partnership based on trust – and trust based on quality

Total Quality by NSK: The synergies of our global network of NSK Technology Centres. Just one example of how we meet our requirements for high quality.

NSK is one of the leading companies with a long tradition in patent applications for machine parts. In our worldwide research centres, we not only concentrate on the development of new technologies, but also on the continual improvement

of quality based on the integrated technology platform of tribology, material technology, analysis and mechatronics.

More about NSK at www.nskeurope.com or call us on +44 (0) 1636 605 123



Features of NH and NS Series

Using NSK's cumulated knowledge and state of the art technology, a new series of standard linear guides has been designed. Based on the LH and LS series which were characterised by high reliability and performance, NSK has achieved a significant increase in durability. Inheriting features such as random matching and the NSK K1 lubrication unit, this new series of linear guides can be used in numerous industrial applications.

1. Excellent durability

Super-long life, twice as long as compared with the conventional series

Compared to the conventional LH and LS series, a load rating 1.3 times greater and a lifetime two times longer have been achieved. These improvements allow the design of machines with longer lifetime and reliability, and also allow the opportunity to downsize while retaining or even improving the original lifetime.

Maintenance-free

The NSK K1 unit (optional), which has an excellent track record in a wide range of application types, assures long term maintenance free operation. As well as maintenance savings, the K1 unit is also environmentally friendly.

What is "NSK K1" lubrication unit?

NSK K1 is a lubrication device which combines oil and resin in a single unit. The porous resin contains a large amount of lubrication oil. Through contact between the surface of the K1 unit and the rail raceway close to the ball contact point, the NSK K1 unit constantly supplies fresh oil to where it is needed most.

2. Easy-to-use "Standard Linear Guides"

Random matching (interchangeable) types are available

Rails and ball slides can be selected in any combination. Random matching is available for all models. Various combinations of different ball slide types, accuracy grades and preload can be made. Short delivery times are also available.

Robust design to absorb mounting errors

Similar to a DF arrangement using angular contact ball bearings, the self aligning capability of the new NH and NS series is high, as the intersection point of the contact lines of the ball and grooves is inside the slider, and thus reduces moment rigidity (Fig. 1). This allows the linear guide to accept greater errors in installation, and results in less effort in achieving a high precision when mounting the linear guide.

Fig. 1

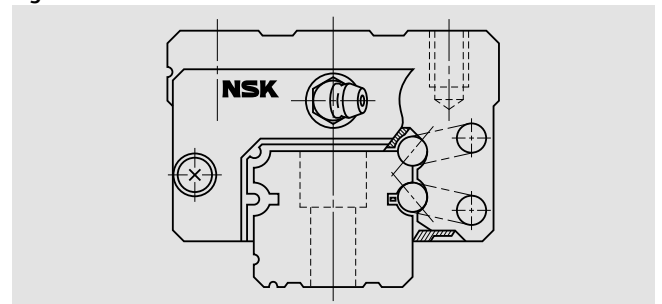

Abundant options

Abundant options are available, including an NSK K1 lubrication unit, double seal, protector, surface treatment, etc. We offer the configuration best suited to the customer's needs.

All mounting dimensions are the same as those for the LH and LS Series

All mounting dimensions such as the mounting height, mounting width, mounting hole diameter/pitch of the linear guide etc., of the new NH series are identical to those of the conventional LH series. The mounting dimensions of the NS series are also identical to the conventional LS series. Therefore the new NH/NS series is fully interchangeable, and no design changes are required.

New standard linear guides produced through state-of-the-art technology

Based on the LH/LS Series, which have achieved exceptional results in numerous application areas ever since their debut in 1989, the new NH/NS Series have been created as the focal point of NSK's cumulated state-of-the-art design and manufacturing technologies.



Ball groove geometry contributes to long life

A new design of ball groove geometry has been introduced, using NSK's state of the art tribological and analytical technologies. By optimising the distribution of contact surface pressures, the rating lifetime has been dramatically increased. Compared to the LH/LS series, the load rating of the new series has been increased by 30%, while the lifetime has doubled. (Representative values of each series)

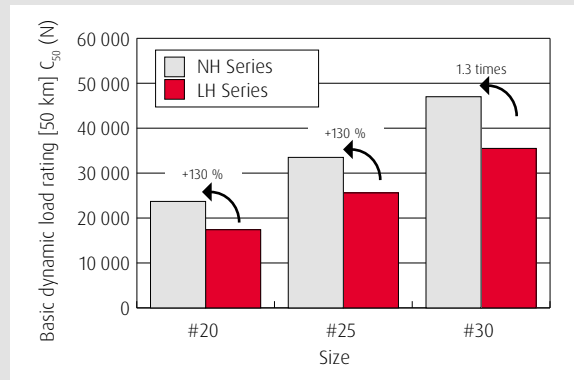

Ball circulating groove with excellent high-speed properties

By reexamining the design practice for the ball circulation path, we have attained smooth ball circulation and a reduced noise level. Therefore, the new NH/NS series are more suitable for high speed applications compared to the LH/LS series.

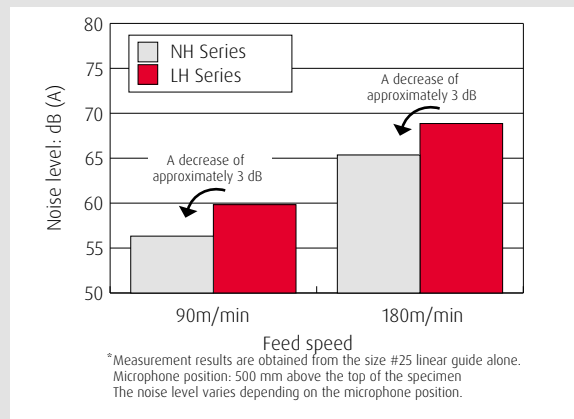

By mounting a NSK K1 lubrication unit (optional), long-term, maintenance-free operation can be achieved.



Specifications

1. Ball Slide Shape

- › Two types of ball slides are available:
 - › Square type with tapped holes
 - › Flanged type
- › For the square type, a compact, low-profile model is also available.
- › On the mounting holes of the flange type, the tapped part is used to fix the ball slide from the top surface, while the minor diameter can be used as a bolt hole for mounting from the bottom. This enables mounting from either direction, top or bottom.
- › The ball slide length is available in three lengths: standard high-load, long super-high load or short medium-load. The ball slide length differs, depending on the type. Please refer to the dimension table.

Fig. 2 Ball slide shape

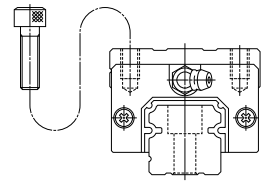
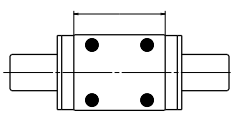
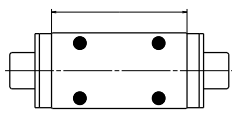
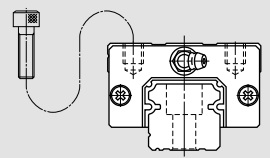
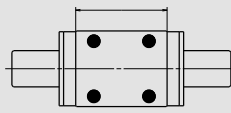
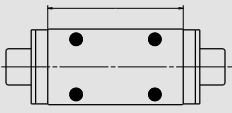
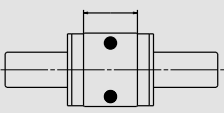
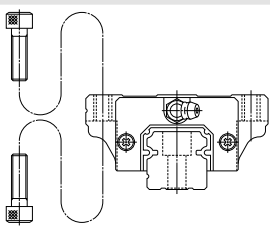
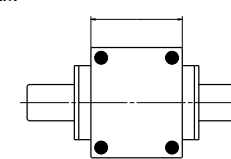
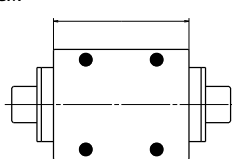
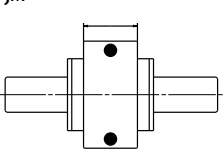
Ball Slide Shape	Shape/installation method	Type (Upper row: Rating; Lower row: Ball slide length)		
		High-load Type	Super-high-load type	Medium-load-type
		Standard	Long	Short
AN BN		AN 	BN 	
AL BL CL		AL 	BL 	CL 
EM GM JM		EM 	GM 	JM 

2. Maximum Rail Length

- › Table 1 shows the limitations of rail length (maximum length).
- › Depending on the required accuracy grade, the available maximum rail length may be shorter than that shown in Table 1.

Table 1 Length limitations of rails

Unit: mm

Series	Material	Size							
		15	20	25	30	35	45	55	65
NH	Special high carbon Steel	2980	3960	3960	4000	4000	3990	3960	3900
	Stainless steel	1800	3500	3500	3500				
NS	Special high carbon steel	2920	3960	3960	4000	4000			
	Stainless steel	1700	3500	3500	3500	3500			

Note: Rails can be butted if user requirement exceeds the rail length shown in the table. Please consult NSK.

3. Accuracy

- › The determination of the accuracy grade differs depending on whether the required type is a preloaded assembly or the random-matching type.
- › For the preloaded assembly, different accuracy grades are available: Ultra precision P3, Super precision P4, High precision P5, Precision P6, and Normal PN grades.
- › Random-matching type has High precision PH and Normal PC grade.

Table 2 Tolerance of preloaded assembly

Unit: μm

Characteristics	Accuracy grade				
	Ultra precision P3	Super precision P4	High precision P5	Precision grade P6	Normal grade PN
Mounting height H Variation of H (All ball slides on a set of rails)	± 10 3	± 10 5	± 20 7	± 40 15	± 80 25
Mounting width W_2 or W_3 Variation of W_2 or W_3 (All ball slides on reference rail)	± 15 3	± 15 7	± 25 10	± 50 20	± 100 30
Running parallelism of surface C to surface A Running parallelism of surface D to surface B	Refer to Fig. 3 and Table 4.				

Table 3 Tolerance of random-matching type

Unit: μm

Characteristics	Accuracy grade			
	High precision grade (PH)		Normal grade (PC)	
Model No.	NH15,20,25,30,35 NS15,20,25,30,35	NH45,55,65	NH15,20,25,30,35 NS15,20,25,30,35	NH45,55,65
Mounting height H	± 20	± 30	± 20	± 30
Variation of mounting height H	15	20	15	20
Mounting width W_2 or W_3	± 30	± 35	± 30	± 35
Variation of mounting width W_2 or W_3	20	20	25	30
Running parallelism of surface C to surface A Running parallelism of surface D to surface B	Refer to Fig. 3 and Table 4.			

Note: Variation in the random-matching products means the variation among the values taken at the same position on the same rail.

Specifications

Table 4 Running parallelism of ball slide

Unit: μm

Rail length (mm)	Preload assembly					Random-matching type	
	Ultra precision P3	Super precision P4	High precision P5	Precision grade P6	Normal grade PN	High precision PH	Normal grade PC
Over ~ 50 or less	2	2	2	4.5	6	2	6
50 ~ 80	2	2	3	5	6	3	6
80 ~ 125	2	2	3.5	5.5	6.5	3.5	6.5
125 ~ 200	2	2	4	6	7	4	7
200 ~ 250	2	2.5	5	7	8	5	8
250 ~ 315	2	2.5	5	8	9	5	9
315 ~ 400	2	3	6	9	11	6	11
400 ~ 500	2	3	6	10	12	6	12
500 ~ 630	2	3.5	7	12	14	7	14
630 ~ 800	2	4.5	8	14	16	8	16
800 ~ 1 000	2.5	5	9	16	18	9	18
1 000 ~ 1 250	3	6	10	17	20	10	20
1 250 ~ 1 600	4	7	11	19	23	11	23
1 600 ~ 2 000	4.5	8	13	21	26	13	26
2 000 ~ 2 500	5	10	15	22	29	15	29
2 500 ~ 3 150	6	11	17	25	32	17	32
3 150 ~ 4 000	9	16	23	30	34	23	34

Fig. 3 Specifications of accuracy

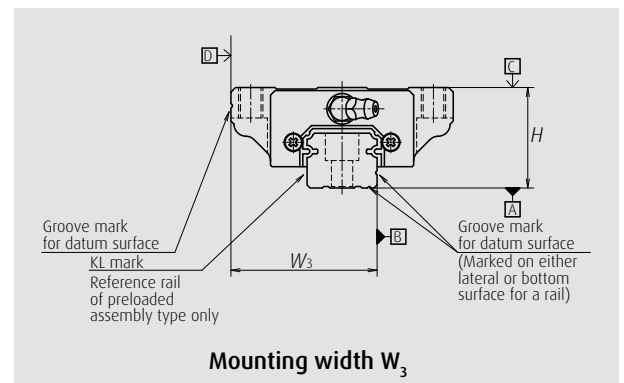
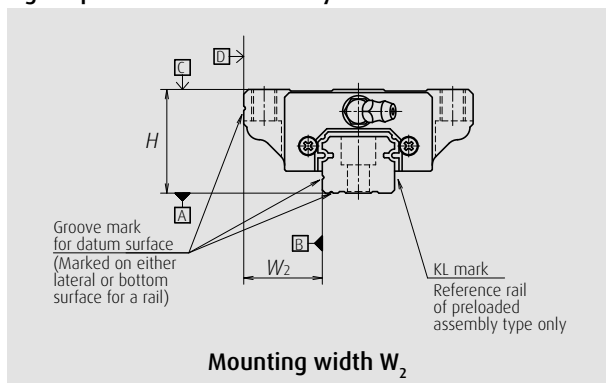

4. Preload and Rigidity

- › Preload setting differs between the preloaded assembly and random-matching types.
- › For the preloaded assembly, Medium preload Z3, Slight preload Z1 and Fine clearance Z0 are available.
- › For the random-matching type, Medium preload ZH, Slight preload ZZ and Fine clearance ZT are available.
- › Possible combinations between the accuracy and preload grades are shown in Table 9.

Table 5 Preload and rigidity of preloaded assembly (1) NH Series

Model No.	Preload (N)		Rigidity (N/μm)			
			Vertical direction		Lateral direction	
	Slight preload (Z1)	Medium preload (Z3)	Slight preload (Z1)	Medium preload (Z3)	Slight preload (Z1)	Medium preload (Z3)
NH15 AN, EM	78	490	137	226	98	186
NH20 AN, EM	147	835	186	335	137	245
NH25 AL, AN, EM	196	1,270	206	380	147	284
NH30 AL, AN	245	1,570	216	400	157	294
NH30 EM	294	1,770	265	480	186	355
NH35 AL, AN, EM	390	2,350	305	560	216	390
NH45 AL, AN, EM	635	3,900	400	745	284	540
NH55 AL, AN, EM	980	5,900	490	910	345	645
NH65 AN, EM	1,470	8,900	580	1,070	400	755
NH15 BN, GM	98	685	196	345	137	284
NH20 BN, GM	196	1,080	265	480	196	355
NH25 BL, BN, GM	245	1,570	294	560	216	400
NH30 BL, BN, GM	390	2,260	360	665	265	480
NH35 BL, BN, GM	490	2,940	430	795	305	570
NH45 BL, BN, GM	785	4,800	520	960	370	695
NH55 BL, BN, GM	1,180	7,050	635	1,170	440	835
NH65 BN, GM	1,860	11,300	805	1,480	550	1,040

Note: Clearance for Fine clearance Z0 is 0 to 3 μm, Therefore, preload is zero. However, Z0 of PN grade is 0 to 15 μm.

Table 6 Clearance and preload of random-matching type (1) NH Series

Unit: μm

Model No.	Fine clearance ZT	Slight preload ZZ	Medium preload ZH
NH15	-4 ~ 15	-4 ~ 0	-3 ~ -7
NH20	-5 ~ 15	-5 ~ 0	-3 ~ -8
NH25		-5 ~ 0	-4 ~ -9
NH30		-7 ~ 0	-5 ~ -12
NH35		-7 ~ 0	-5 ~ -12
NH45		-7 ~ 0	-7 ~ -14
NH55		-9 ~ 0	-9 ~ -18
NH65		-9 ~ 0	-10 ~ -19

Note: Minus sign denotes a value is an amount of preload (elastic deformation of balls).

Specifications

Table 7 Preload and rigidity of preloaded assembly (2) NS Series

Model No.	Preload (N)		Rigidity (N/μm)			
			Vertical direction		Lateral direction	
	Slight preload (Z1)	Medium preload (Z3)	Slight preload (Z1)	Medium preload (Z3)	Slight preload (Z1)	Medium preload (Z3)
NS15 AL, EM	69	390	127	226	88	167
NS20 AL, EM	88	540	147	284	108	206
NS25 AL, EM	147	880	206	370	147	275
NS30 AL, EM	245	1,370	255	460	186	345
NS35 AL, EM	345	1,960	305	550	216	400
NS15 CL, JM	49	294	78	147	59	108
NS20 CL, JM	69	390	108	186	78	137
NS25 CL, JM	98	635	127	235	88	177
NS30 CL, JM	147	980	147	275	108	206
NS35 CL, JM	245	1,370	186	335	137	245

Note: Clearance for Fine clearance Z0 is 0 to 3 μm, Therefore, preload is zero. However, Z0 of PN grade is 0 to 15 μm.

Table 8 Clearance and preload of random-matching type (2) NS Series

Unit: μm

Model No.	Fine clearance (ZT)	Slight preload (ZZ)	Medium preload (ZH)
NS15	-4 ~ 15	-4 ~ 0	-3 ~ -7
NS20	-4 ~ 15	-4 ~ 0	-3 ~ -7
NS25	-5 ~ 15	-5 ~ 0	-4 ~ -9
NS30	-5 ~ 15	-5 ~ 0	-4 ~ -9
NS35	-5 ~ 15	-6 ~ 0	-4 ~ -10

Note: Minus sign denotes a value is an amount of preload (elastic deformation of balls).

Table 9 Combinations of accuracy and preload

	Accuracy grade							
	Ultra precision	Super precision	High precision	Precision grade	Normal grade	High precision	Normal grade	
Without NSK K1 lubrication unit	P3	P4	P5	P6	PN	PH	PC	
With NSK K1 lubrication unit	K3	K4	K5	K6	KN	KH	KC	
With NSK K1 for food and medical equipment	F3	F4	F5	F6	FN	FH	FC	
Preload	Fine clearance Z0	●	●	●	●	●	—	—
	Slight preload Z1	●	●	●	●	●	—	—
	Medium preload Z3	●	●	●	●	—	—	—
	Random-matching type with fine clearance ZT	—	—	—	—	—	—	●
	Random-matching type with slight preload ZZ	—	—	—	—	—	●	●
Random-matching type with medium preload ZH	—	—	—	—	—	●	●	

5. Dust-proof parts and Lubrication accessories

(1) Standard specification

- › As standard, ball slides have an end seal on both ends and bottom seals underneath.
This standard configuration can be used for normal application conditions
- › For more challenging application conditions, optional dust proof parts are available as shown in Table 10

Table 10 Optional dust-proof parts

Name	Purpose
NSK K1 lubrication unit	Made of oil impregnated resin. Enhances lubricating functions.
Double seal	Combines two end seals for enhanced sealing function.
Protector	Protects the end seal from hot and hard contaminants.
Rail cap	Prevents foreign matter such as swarf generated in cutting operation from clogging the rail-mounting holes.
Inner seal	Installed inside a slide, and prevents foreign matter from entering the rolling contact surface.
Bellows	Covers the linear guide.

Note: Inner seals can be selected for NH20-65 and NS20-35.

Fig. 4

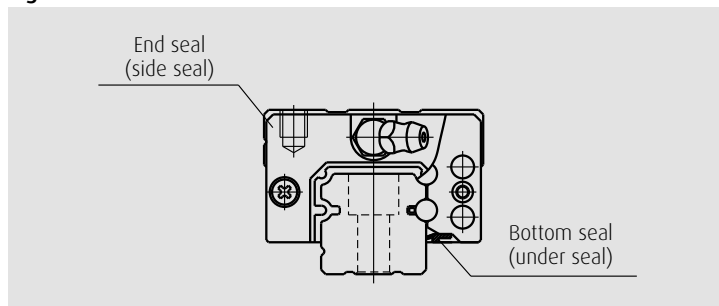

(2) Mounting position of lubrication accessories

- › The standard position of grease fittings is the end face of ball slide.
Grease fittings can also be optionally mounted on the side of the end cap. (Fig. 5).
- › Please consult NSK for installation of grease or tube fittings to the ball slide body or side of end cap.

Fig. 5 Mounting position of lubrication accessories

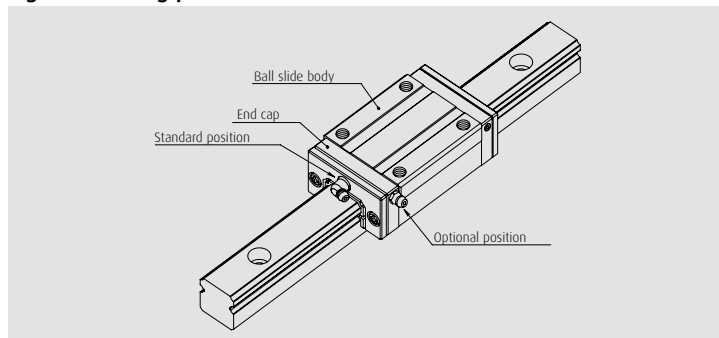

Specifications

(3) NSK K1 Lubrication unit

Table 11 shows the dimensions of linear guides equipped with the NSK K1 lubrication unit.

Table 11

Unit: mm

Model No.	Standard ball slide length	Ball slide length installed with two NSK K1 L	Per NSK K1 thickness V_1	Protective cover thickness V_2	Protruding area of the grease fitting N	
NH15	AN, EM BN, GM	55 74	65.6 84.6	4.5	0.8	(5)
NH20	AN, EM BN, GM	69.8 91.8	80.4 102.4	4.5	0.8	(14)
NH25	AL, AN, EM BL, BN, GM	79 107	90.6 118.6	5	0.8	(14)
NH30	AL, AN EM BL, BN, GM	85.6 98.6 124.6	97.6 110.6 136.6	5	1	(14)
NH35	AL, AN, EM BL, BN, GM	109 143	122 156	5.5	1	(14)
NH45	AL, AN, EM BL, BN, GM	139 171	154 186	6.5	1	(15)
NH55	AL, AN, EM BL, BN, GM	163 201	178 216	6.5	1	(15)
NH65	AN, EM BN, GM	193 253	211 271	8	1	(16)
NS15	AL, EM CL, JM	56.8 40.4	66.4 50	4	0.8	(5)
NS20	AL, EM CL, JM	65.2 47.2	75.8 57.8	4.5	0.8	(14)
NS25	AL, EM CL, JM	81.6 59.6	92.2 70.2	4.5	0.8	(14)
NS30	AL, EM CL, JM	96.4 67.4	108.4 79.4	5	1	(14)
NS35	AL, EM CL, JM	108 77	121 90	5.5	1	(14)

Notes:

(1) NSK K1 for food and medical equipment are available for NH15-35 and NS15-35.

(2) Ball slide length equipped with NSK K1 = (Standard ball slide length) + (Thickness of NSK K1, V_1 x Number of NSK K1) + (Thickness of the protective cover, V_2 x 2)

Fig. 6

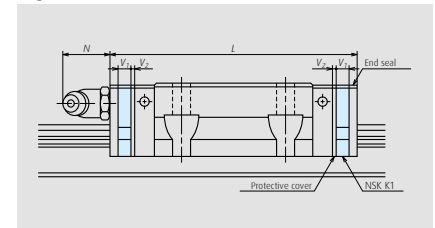

6. Rust Prevention

(1) Stainless steel

Slide components made of carbon steel can also be supplied in stainless steel material. The models which can be made with stainless steel are NH15-30 and NS15-35. However, the high precision (PH) grade and the medium preload (ZH) type of the random-matching type can not be made from stainless steel.

(2) Surface treatment

For surface treatment, NSK recommends low temperature chrome plating or fluoride low temperature chrome plating. Please consult NSK for other surface treatment.

Table 12 Material/surface treatment code

Code	Description
C	Special high carbon steel (NSK standard)
K	Stainless steel
D	Special high carbon steel with surface treatment
H	Stainless steel with surface treatment
Z	Other, special

7. Installation

(1) Permissible values of mounting error

Mounting errors may result in harmful effects, such as shortened operating life, deterioration of motion accuracy and/or friction variation. Using the mounting error types shown in Figures 7 and 8 as representative errors, Tables 13 and 14 show the mounting tolerances.

Fig. 7

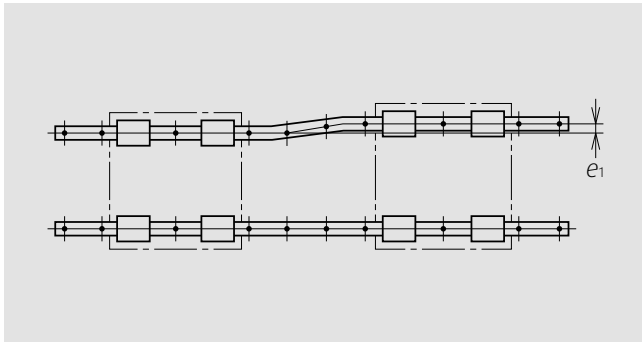

Fig. 8

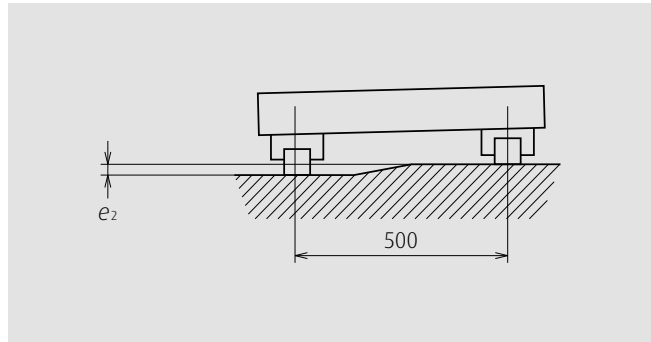

Table 13

Unit: μm

Value	Preload	Model No.							
		NH15	NH20	NH25	NH30	NH35	NH45	NH55	NH65
Permissible values of parallelism in two rails e_1	Z0, ZT	22	30	40	45	55	65	80	110
	Z1, ZZ	18	20	25	30	35	45	55	70
	Z3, ZH	13	15	20	25	30	40	45	60
Permissible values of parallelism (height) in two rails e_2	Z0, ZT	375 $\mu\text{m}/500\text{mm}$							
	Z1, ZZ, Z3, ZH	330 $\mu\text{m}/500\text{mm}$							

Table 14

Unit: μm

Value	Preload	Model No.				
		NS15	NS20	NS25	NS30	NS35
Permissible values of parallelism in two rails e_1	Z0, ZT	20	22	30	35	40
	Z1, ZZ	15	17	20	25	30
	Z3, ZH	12	15	15	20	25
Permissible values of parallelism (height) in two rails e_2	Z0, ZT	375 $\mu\text{m}/500\text{mm}$				
	Z1, ZZ, Z3, ZH	330 $\mu\text{m}/500\text{mm}$				

Specifications

(2) Shoulder height and corner radius of the mounting surface

When horizontally fixing a rail or ball slide by pushing it to the shoulder (the raised portion of the mounting surface) of the bed or table, refer to the shoulder height and corner radius specified in Fig. 9 and 10 and Table 15.

Shoulder height of the mounting surface and corner radius r

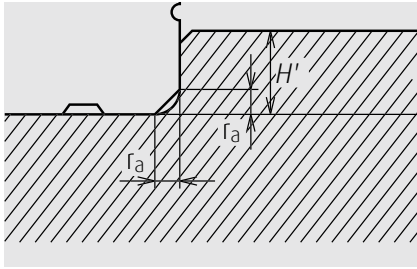

Fig. 9 Shoulder for the rail datum surface

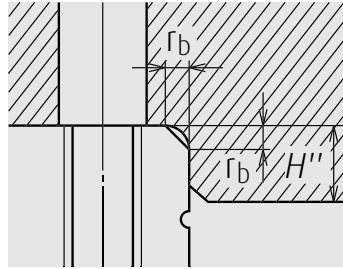

Fig. 10 Shoulder for the ball slide datum surface

Table 15

Unit: mm

Model No.	Corner radius (maximum)		Shoulder height	
	r_a	r_b	H'	H''
NH15	0.5	0.5	4	4
NH20	0.5	0.5	4.5	5
NH25	0.5	0.5	5	5
NH30	0.5	0.5	6	6
NH35	0.5	0.5	6	6
NH45	0.7	0.7	8	8
NH55	0.7	0.7	10	10
NH65	1	1	11	11
NS15	0.5	0.5	4	4
NS20	0.5	0.5	4.5	5
NS25	0.5	0.5	5	5
NS30	0.5	0.5	6	6
NS35	0.5	0.5	6	6

8. Maximum allowable speed

Table 16 shows an indication of the standard maximum allowable speed, considering a operational lifetime of 10000km with normal operating conditions. However, the maximum allowable speed can be affected by accuracy of installation, operating temperature, external load, etc. If the permissible distance or speed are exceeded, please contact NSK.

Table 16 Maximum allowable speed

Unit: m/min

Series	Size							
	15	20	25	30	35	45	55	65
NH			300				200	150
NS			300				—	—

9. Handling Precautions

- (1) Heavy impact or shock loads may damage the slide and rail.
- (2) Operating temperature should be less than 80°C. If this temperature is exceeded, the plastic components of the slide may be damaged.
- (3) If using NSK K1, maximum temperature in use : 50°C momentary maximum temperature in use: 80°C). Do not leave NSK K1 lubrication unit in organic solvent, white kerosene such as hexane, thinner which removes oil, and rust prevention oil which contains white kerosene.
- (4) Regarding the handling of random-matching products.
 - a) Slides of random-matching type are assembled on a provisional rail (an inserting tool) when it is delivered.
 - b) When a slide is mounted on a rail, the provisional rail should always be used as a guide.
 - c) Sliders should not be removed from the provisional rail, except when mounting on a rail.

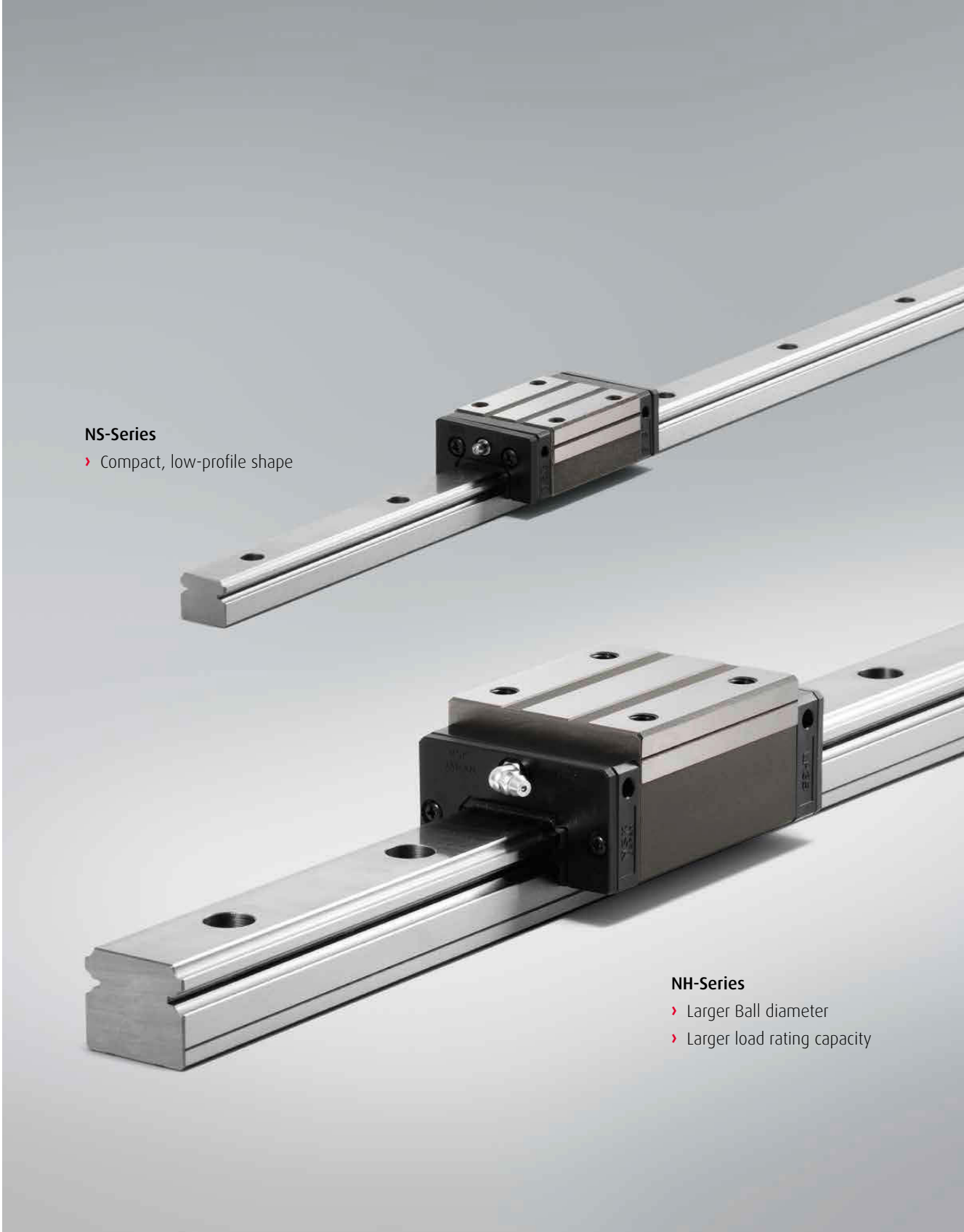

NS-Series

- › Compact, low-profile shape

NH-Series

- › Larger Ball diameter
- › Larger load rating capacity

Specifications

11. Dimensions

NH-AN (High load type/standard, square type)

NH-BN (Super-high-load type/long, square type)

(1) Reference number for assembly

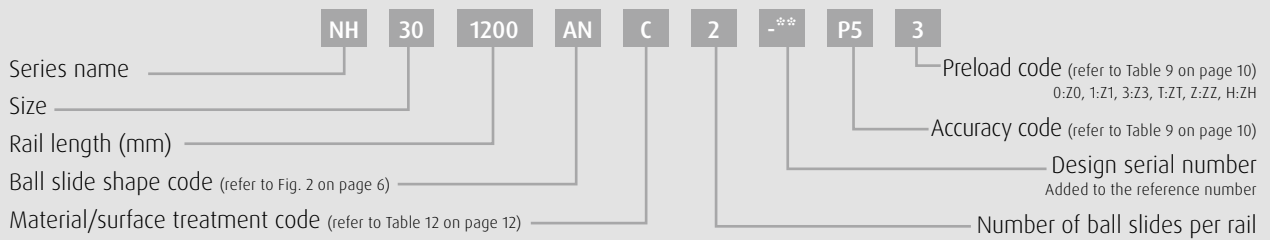

Assembly (Preloaded assembly, random-matching type)

Front view of AN and BN types

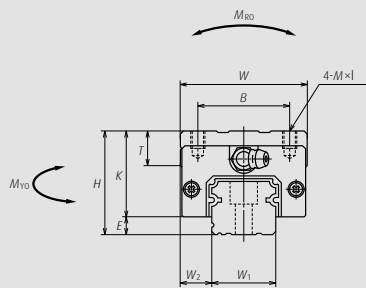

Side view of AN type

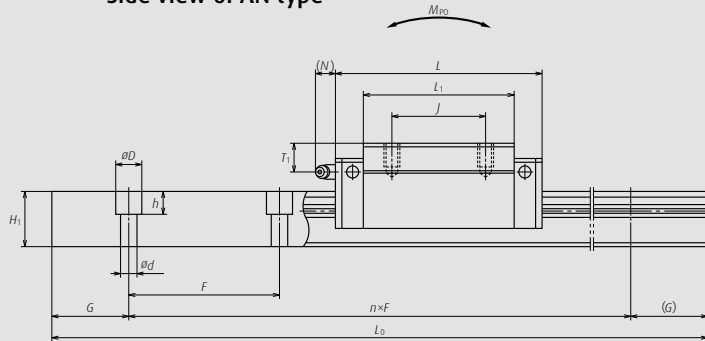

Side view of BN type

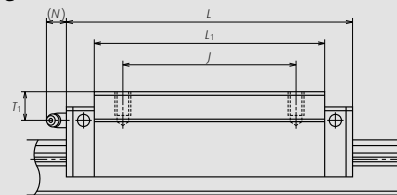

Model No.	Assembly					Ball slide										Width W ₁	Height H ₁
	Height H	E	W ₂	Width W	Length L	Mounting hole			L ₁	K	T	Grease fitting					
						B	J	M×Pitch×l				Hole size	T ₁	N			
NH15AN NH15BN	28	4.6	9.5	34	55 74	26	26	M4×0.7×6	39 58	23.4	8	∅3	8.5	3.3	15	15	
NH20AN NH20BN	30	5	12	44	69.8 91.8	32	36 50	M5×0.8×6	50 72	25	12	M6×0.75	5	11	20	18	
NH25AN NH25BN	40	7	12.5	48	79 107	35	35 50	M6×1×9	58 86	33	12	M6×0.75	10	11	23	22	
NH30AN NH30BN	45	9	16	60	85.6 124.6	40	40 60	M8×1.25×10	59 98	36	14	M6×0.75	10	11	28	26	
NH35AN NH35BN	55	9.5	18	70	109 143	50	50 72	M8×1.25×12	80 114	45.5	15	M6×0.75	15	11	34	29	
NH45AN NH45BN	70	14	20.5	86	139 171	60	60 80	M10×1.5×17	105 137	56	17	Rc1/8	20	13	45	38	
NH55AN NH55BN	80	15	23.5	100	163 201	75	75 95	M12×1.75×18	126 164	65	18	Rc1/8	21	13	53	44	
NH65AN NH65BN	90	16	31.5	126	193 253	76	70 120	M16×2×20	147 207	74	23	Rc1/8	19	13	63	53	

Notes: 1) External appearance of stainless steel ball slides differs from those of carbon steel ball slides.

(2) Reference number for random-matching type

Ball Slide

Random-matching ball slide series code

NAH: NH Series random-matching ball slide

Size

Ball slide shape code

(refer to Fig. 2 on page 6)

NAH 30 AN S Z -K

Option code
 -K: Equipped with NSK K1
 -F: Fluoride low temperature chrome plating + AS2 grease
 -F50: Fluoride low temperature chrome plating + LG2 grease
 Preload code
 No code: Fine clearance, Z: Slight preload, H: Medium preload
 Material code
 No code: Special high carbon steel (NSK standard),
 S: Stainless steel

AN and BN types

AN type

BN type

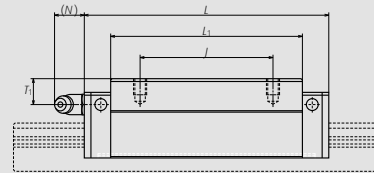
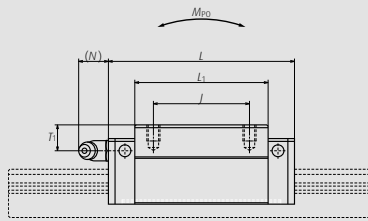
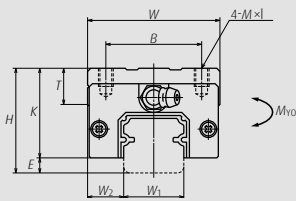

Rail

Random-matching rail series code

N1H: NH Series random-matching rail

Size

Rail length (mm)

Rail shape code: L

L: Standard

Material/surface treatment code (refer to Table 12 on page 12)

N1H 30 1200 L C N - ** PC Z

Preload code
 (refer to Table 9 on page 10)
 T: Fine clearance,
 Z: Slight preload
 (common rail for slight or medium preload)
 Accuracy code
 PH: High precision grade random-matching type
 PC: Normal grade random-matching type
 Design serial number
 Added to the reference number
 Butting rail specification*
 N: Non-butting; L: Butting specification
 *Please consult with NSK for butting rail specification.

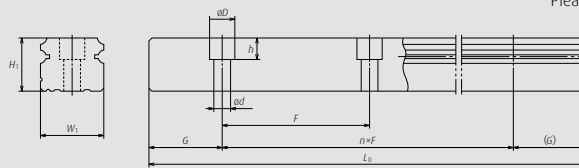

Unit: mm

Rail				Basic load rating									Weight	
Pitch F	Mounting bolt hole d×D×h	G (reference)	Max. length L _{0max} (for stainless)	Dynamic		Static	M _{ro}	Static moment (N-m)				Ball slide (kg)	Rail (kg/m)	
				[50km] C ₅₀ (N)	[100km] C ₁₀₀ (N)	C ₀ (N)		M _{po}		M _{yo}				
								(One slide)	(Two slides)	(One slide)	(Two slides)			
60	4.5×7.5×5.3	20.0	2,980	14,200	11,300	20,700	108	94.5	575	79.5	480	0.18	1.6	
			(1,800)	18,100	14,400	32,000	166	216	1,150	181	965	0.26		
60	6×9.5×8.5	20.0	3,960	23,700	18,800	32,500	219	185	1,140	155	955	0.33	2.6	
			(3,500)	30,000	24,000	50,500	340	420	2,230	355	1,870	0.48		
60	7×11×9	20.0	3,960	33,500	26,800	46,000	360	320	1,840	267	1,540	0.55	3.6	
			(3,500)	45,500	36,500	71,000	555	725	3,700	610	3,100	0.82		
80	9×14×12	20.0	4,000	41,000	32,500	51,500	490	350	2,290	292	1,920	0.77	5.2	
			(3,500)	61,000	48,500	91,500	870	1,030	5,600	865	4,700	1.3		
80	9×14×12	20.0	4,000	62,500	49,500	80,500	950	755	4,500	630	3,800	1.5	7.2	
				81,000	64,500	117,000	1,380	1,530	8,350	1,280	7,000	2.1		
105	14×20×17	22.5	3,990	107,000	84,500	140,000	2,140	1,740	9,750	1,460	8,150	3.0	12.3	
				131,000	104,000	187,000	2,860	3,000	15,600	2,520	13,100	3.9		
120	16×23×20	30.0	3,960	158,000	125,000	198,000	3,600	3,000	16,300	2,510	13,700	4.7	16.9	
				193,000	153,000	264,000	4,850	5,150	26,300	4,350	22,100	6.1		
150	18×26×22	35.0	3,900	239,000	190,000	281,000	6,150	4,950	27,900	4,150	23,400	7.7	24.3	
				310,000	246,000	410,000	8,950	10,100	51,500	8,450	43,500	10.8		

2) The basic load rating complies with ISO standard. (ISO14728-1 and ISO14728-2)

C₅₀: the basic dynamic load rating for 50 km rating fatigue life, C₁₀₀: the basic dynamic load rating for 100 km rating fatigue life.

Specifications

NH-AL (High load type/standard, square low-profile type)

NH-BL (Super-high-load type/long, square low-profile type)

(1) Reference number for assembly

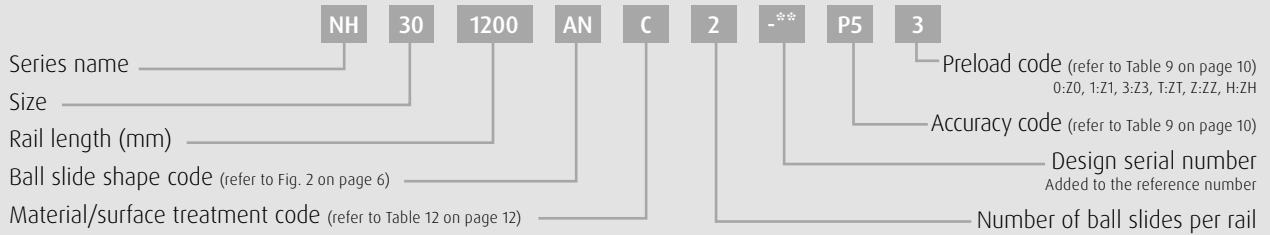

Assembly (Preloaded assembly, random-matching type)

Front view of AL and BL types

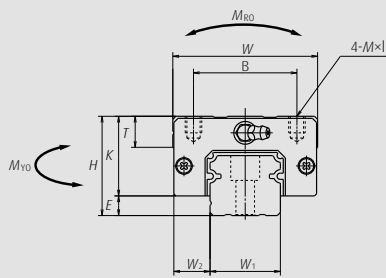

Side view of AL type

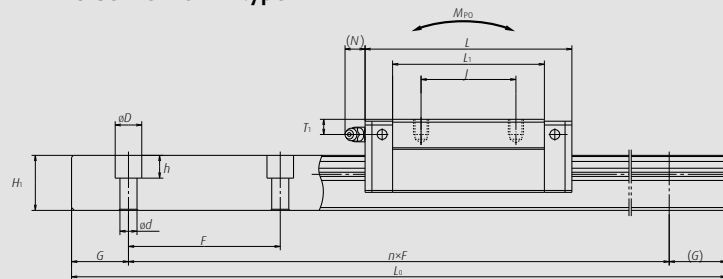

Side view of BL type

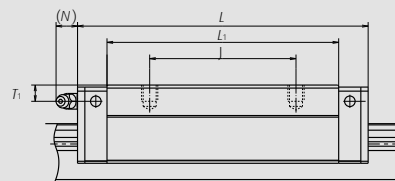

Model No.	Assembly					Ball slide										
	Height H	E	W ₂	Width W	Length L	Mounting hole			L ₁	K	T	Grease fitting			Width W ₁	Height H ₁
						B	J	M×Pitch×I				Hole size	T ₁	N		
NH25AL NH25BL	36	7	12.5	48	79 107	35	35 50	M6×1×6	58 86	29	12	M6×0.75	6	11	23	22
NH30AL NH30BL	42	9	16	60	85.6 124.6	40	40 60	M8×1.25×8	59 98	33	14	M6×0.75	7	11	28	26
NH35AL NH35BL	48	9.5	18	70	109 143	50	50 72	M8×1.25×8	80 114	38.5	15	M6×0.75	8	11	34	29
NH45AL NH45BL	60	14	20.5	86	139 171	60	60 80	M10×1.5×10	105 137	46	17	Rc1/8	10	13	45	38
NH55AL NH55BL	70	15	23.5	100	163 201	75	75 95	M12×1.75×13	126 164	55	15	Rc1/8	11	13	53	44

Notes: 1) External appearance of stainless steel ball slides differs from those of carbon steel ball slides.

(2) Reference number for random-matching type

Ball Slide

Random-matching ball slide series code

NAH: NH Series random-matching ball slide

Size

Ball slide shape code
(refer to Fig. 2 on page 6)

NAH 30 AL S Z -K

Option code
-K: Equipped with NSK K1
-F: Fluoride low temperature chrome plating + AS2 grease
-F50: Fluoride low temperature chrome plating + LG2 grease
Preload code
No code: Fine clearance, Z: Slight preload, H: Medium preload
Material code
No code: Special high carbon steel (NSK standard),
S: Stainless steel

AL and BN types

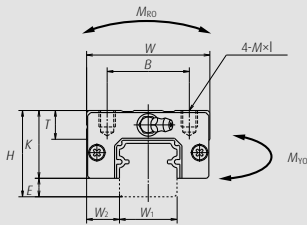

AL type

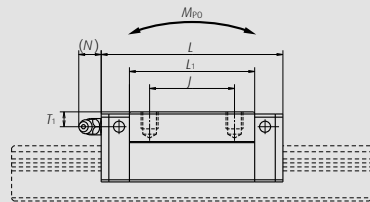

BL type

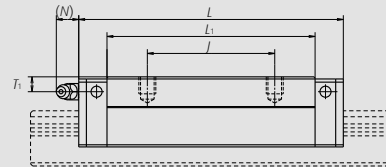

Rail

Random-matching rail series code

N1H: NH Series random-matching rail

Size

Rail length (mm)

Rail shape code: L
L: Standard

Material/surface treatment code (refer to Table 12 on page 12)

N1H 30 1200 L C N - ** PC Z

Preload code
(refer to Table 9 on page 10)
T: Fine clearance,
Z: Slight preload
(common rail for slight or medium preload)
Accuracy code
PH: High precision grade random-matching type
PC: Normal grade random-matching type
Design serial number
Added to the reference number
Butting rail specification*
N: Non-butting; L: Butting specification
*Please consult with NSK for butting rail specification.

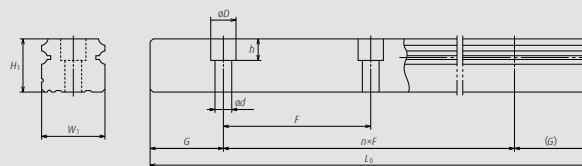

Unit: mm

Rail	Pitch F	Mounting bolt hole d×D×h	G (reference)	Max. length L _{0max} (for stainless)	Basic load rating								Weight	
					2)Dynamic		Static	M _{Ro}	Static moment (N·m)				Ball slide (kg)	Rail (kg/m)
					[50km] C ₅₀ (N)	[100km] C ₁₀₀ (N)	C ₀ (N)		M _{P0}		M _{V0}			
							(One slide)	(Two slides)	(One slide)	(Two slides)				
60	7×11×9	20.0	3,960 (3,500)	33,500	26,800	46,000	360	320	1,840	267	1,540	0.46	3.6	
				45,500	36,500	71,000	555	725	3,700	610	3,100	0.69		
80	9×14×12	20.0	4,000 (3,500)	41,000	32,500	51,500	490	350	2,290	292	1,920	0.69	5.2	
				61,000	48,500	91,500	870	1,030	5,600	865	4,700	1.16		
80	9×14×12	20.0	4,000	62,500	49,500	80,500	950	755	4,500	630	3,800	1.2	7.2	
				81,000	64,500	117,000	1,380	1,530	8,350	1,280	7,000	1.7		
105	14×20×17	22.5	3,990	107,000	84,500	140,000	2,140	1,740	9,750	1,460	8,150	2.2	12.3	
				131,000	104,000	187,000	2,860	3,000	15,600	2,520	13,100	2.9		
120	16×23×20	30.0	3,960	158,000	125,000	198,000	3,600	3,000	16,300	2,510	13,700	3.7	16.9	
				193,000	153,000	264,000	4,850	5,150	26,300	4,350	22,100	4.7		

2) The basic load rating complies with ISO standard. (ISO14728-1 and ISO14728-2)

C₅₀: the basic dynamic load rating for 50 km rating fatigue life, C₁₀₀: the basic dynamic load rating for 100 km rating fatigue life;

Specifications

NH-EM (High-load type/standard, flange type)

NH-GM (Super-high-load type/long, flange type)

(1) Reference number for assembly

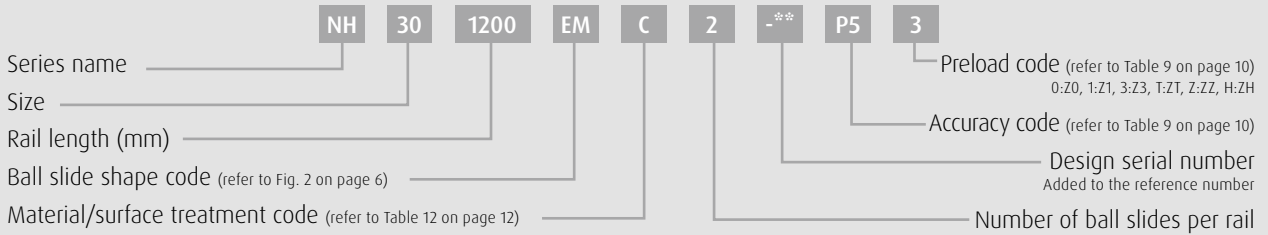

Assembly (Preloaded assembly, random-matching type)

Front view of EM and GM types

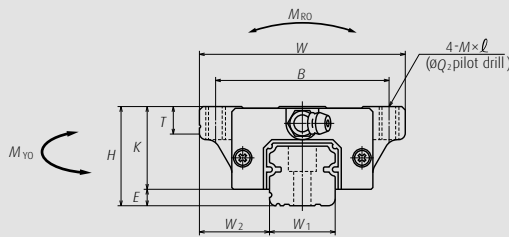

Side view of EM type

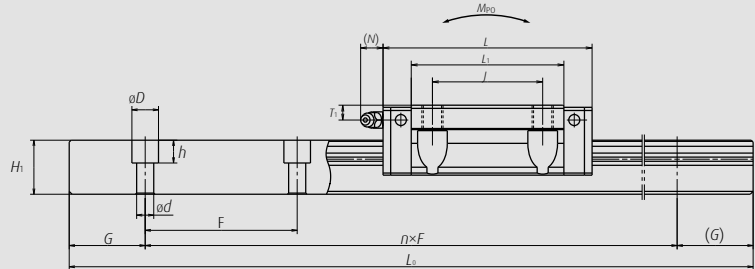

Side view of GM type

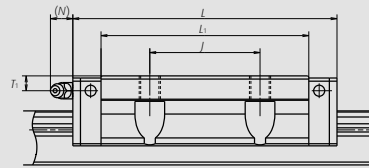

Model No.	Assembly					Ball slide											
	Height H	E	W ₂	Width W	Length L	Mounting hole				L ₁	K	T	Grease fitting			Width W ₁	Height H ₁
						B	J	M×Pitch×l	Q ₂				Hole size	T ₁	N		
NH15EM NH15GM	24	4.6	16	47	55 74	38	30	M5×0.8×7	4.4	39 58	19.4	8	∅3	4.5	3.3	15	15
NH20EM NH20GM	30	5	21.5	63	69.8 91.8	53	40	M6×1×9.5	5.3	50 72	25	10	M6×0.75	5	11	20	18
NH25EM NH25GM	36	7	23.5	70	79 107	57	45	M8×1.25×10 (M8×1.25×11.5)	6.8	58 86	29	11 (12)	M6×0.75	6	11	23	22
NH30EM NH30GM	42	9	31	90	98.6 124.6	72	52	M10×1.5×12 (M10×1.5×14.5)	8.6	72 98	33	11 (15)	M6×0.75	7	11	28	26
NH35EM NH35GM	48	9.5	33	100	109 143	82	62	M10×1.5×13	8.6	80 114	38.5	12	M6×0.75	8	11	34	29
NH45EM NH45GM	60	14	37.5	120	139 171	100	80	M12×1.75×15	10.5	105 137	46	13	Rc1/8	10	13	45	38
NH55EM NH55GM	70	15	43.5	140	163 201	116	95	M14×2×18	12.5	126 164	55	15	Rc1/8	11	13	53	44
NH65EM NH65GM	90	16	53.5	170	193 253	142	110	M16×2×24	14.6	147 207	74	23	Rc1/8	19	13	63	53

Notes: 1) Parenthesized dimensions are for items made of stainless steel.
 2) External appearance of stainless steel ball slides differs from those of carbon steel ball slides.

(2) Reference number for random-matching type

Ball Slide

Random-matching ball slide series code

NAH: NH Series random-matching ball slide

Size

Ball slide shape code
(refer to Fig. 2 on page 6)

NAH 30 EM S Z -K

Option code
-K: Equipped with NSK K1
-F: Fluoride low temperature chrome plating + AS2 grease
-F50: Fluoride low temperature chrome plating + LG2 grease
Preload code
No code: Fine clearance, Z: Slight preload, H: Medium preload
Material code
No code: Special high carbon steel (NSK standard),
S: Stainless steel

EM and GM types

EM type

GM type

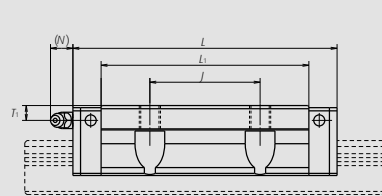
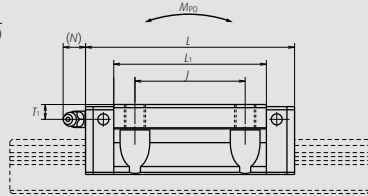
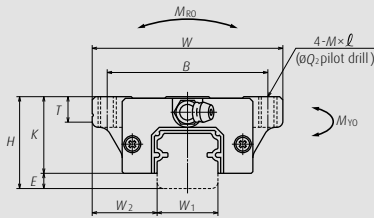

Rail

Random-matching rail series code

N1H: NH Series random-matching rail

Size

Rail length (mm)

Rail shape code: L
L: Standard

Material/surface treatment code (refer to Table 12 on page 12)

N1H 30 1200 L C N - ** PC Z

Preload code
(refer to Table 9 on page 10)
T: Fine clearance,
Z: Slight preload
(common rail for slight or medium preload)
Accuracy code
PH: High precision grade random-matching type
PC: Normal grade random-matching type
Design serial number
Added to the reference number
Butting rail specification*
N: Non-butting; L: Butting specification
*Please consult with NSK for butting rail specification.

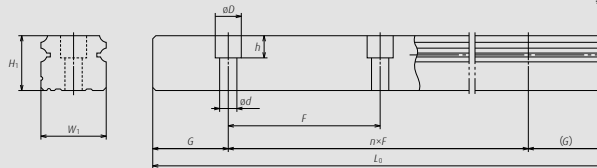

Unit: mm

Rail	Pitch F	Mounting bolt hole d×D×h	G (reference)	Max. length L _{0max} (for stainless)	Basic load rating								Weight	
					Dynamic		Static C ₀ (N)	M ₈₀	Static moment (N-m)				Ball slide (kg)	Rail (kg/m)
					[50km] C ₅₀ (N)	[100km] C ₁₀₀ (N)			M _{PO}		M _{VO}			
								(One slide)	(Two slides)	(One slide)	(Two slides)			
60	4.5×7.5×5.3	20.0	2,980	2,980	14,200	11,300	20,700	108	94.5	575	79.5	480	0.17	1.6
				(1,800)	18,100	14,400	32,000	166	216	1,150	181	965		
60	6×9.5×8.5	20.0	3,960	23,700	18,800	32,500	219	185	1,140	155	955	0.45	2.6	
			(3,500)	30,000	24,000	50,500	340	420	2,230	355	1,870			
60	7×11×9	20.0	3,960	33,500	26,800	46,000	360	320	1,840	267	1,540	0.63	3.6	
			(3,500)	45,500	36,500	71,000	555	725	3,700	610	3,100	0.93		
80	9×14×12	20.0	4,000	47,000	37,500	63,000	600	505	3,150	425	2,650	1.2	5.2	
			(3,500)	61,000	48,500	91,500	870	1,030	5,600	865	4,700	1.6		
80	9×14×12	20.0	4,000	62,500	49,500	80,500	950	755	4,500	630	3,800	1.7	7.2	
				81,000	64,500	117,000	1,380	1,530	8,350	1,280	7,000	2.4		
105	14×20×17	22.5	3,990	107,000	84,500	140,000	2,140	1,740	9,750	1,460	8,150	3	12.3	
				131,000	104,000	187,000	2,860	3,000	15,600	2,520	13,100	3.9		
120	16×23×20	30.0	3,960	158,000	125,000	198,000	3,600	3,000	16,300	2,510	13,700	5	16.9	
				193,000	153,000	264,000	4,850	5,150	26,300	4,350	22,100	6.5		
150	18×26×22	35.0	3,900	239,000	190,000	281,000	6,150	4,950	27,900	4,150	23,400	10	24.3	
				310,000	246,000	410,000	8,950	10,100	51,500	8,450	43,500	14.1		

3) The basic load rating complies with ISO standard. (ISO14728-1 and ISO14728-2).

C₅₀: the basic dynamic load rating for 50 km rating fatigue life; C₁₀₀: the basic dynamic load rating for 100 km rating fatigue life;

Specifications

NS-CL (Medium-load type/short, square low-profile type)

NS-AL (High-load type/standard, square low-profile type)

(1) Reference number for assembly

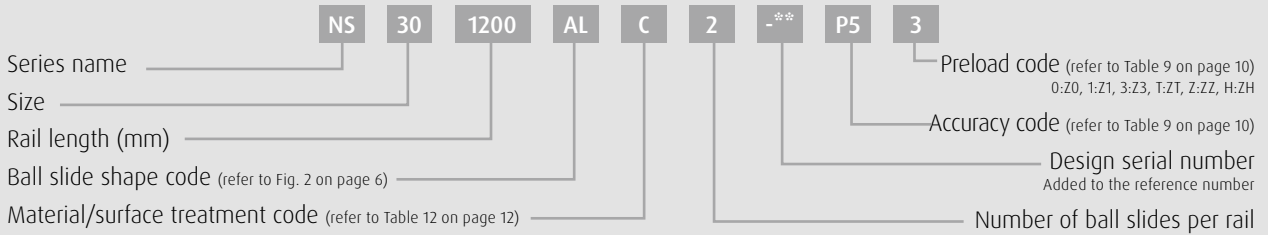

Assembly (Preloaded assembly, random-matching type)

Front view of AL and CL types

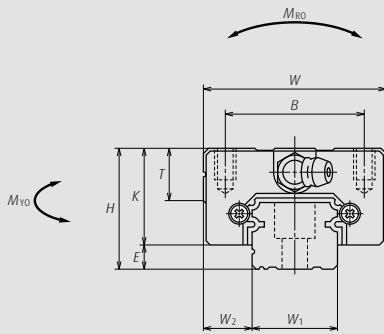

Side view of AL type

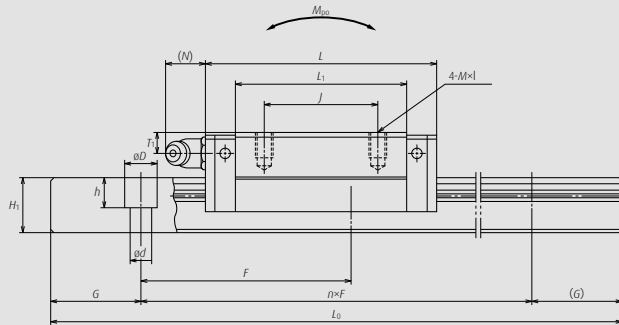

Side view of CL type

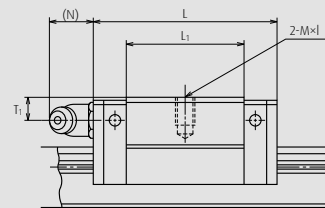

Model No.	Assembly					Ball slide										
	Height H	E	W ₂	Width W	Length L	Mounting hole			L ₁	K	T	Grease fitting			Width W ₁	Height H ₁
						B	J	M×Pitch×l				Hole size	T ₁	N		
NS15CL NS15AL	24	4.6	9.5	34	40.4 56.8	26	— 26	M4×0.7×6	23.6 40	19.4	10	ø3	6	3	15	12.5
NS20CL NS20AL	28	6	11	42	47.2 65.2	32	— 32	M5×0.8×7	30 48	22	12	M6×0.75	5.5	11	20	15.5
NS25CL NS25AL	33	7	12.5	48	59.6 81.6	35	— 35	M6×1×9	38 60	26	12	M6×0.75	7	11	23	18
NS30CL NS30AL	42	9	16	60	67.4 96.4	40	— 40	M8×1.25×12	42 71	33	13	M6×0.75	8	11	28	23
NS35CL NS35AL	48	10.5	18	70	77 108	50	— 50	M8×1.25×12	49 80	37.5	14	M6×0.75	8.5	11	34	27.5

Notes: 1) External appearance of stainless steel ball slides differs from those of carbon steel ball slides.

(2) Reference number for random-matching type

Ball Slide

Random-matching ball slide series code

NAS: NS Series random-matching ball slide

Size

Ball slide shape code
(refer to Fig. 2 on page 6)

NAS 30 AL S Z -K

Option code
-K: Equipped with NSK K1
-F: Fluoride low temperature chrome plating + AS2 grease
-F50: Fluoride low temperature chrome plating + LG2 grease
Preload code
No code: Fine clearance, Z: Slight preload, H: Medium preload
Material code
No code: Special high carbon steel (NSK standard),
S: Stainless steel

AL and CL types

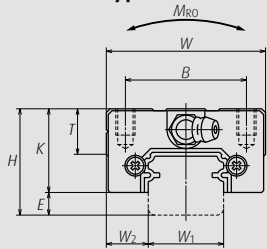

AL type

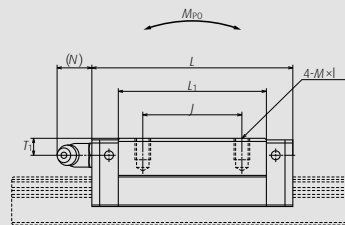

CL type

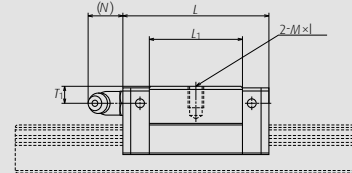

Rail

Random-matching rail series code

N1S: NS Series random-matching rail

Size

Rail length (mm)

Rail shape code: L

L: Standard, T: The rail mounting bolt hole M4 for NS15

Material/surface treatment code (refer to Table 12 on page 12)

N1S 30 1200 L C N - PC Z**

Preload code
(refer to Table 9 on page 10)
T: Fine clearance,
Z: Slight preload
(common rail for slight or medium preload)
Accuracy code
PH: High precision grade random-matching type
PC: Normal grade random-matching type
Design serial number
Added to the reference number
Butting rail specification*
N: Non-butting; L: Butting specification
*Please consult with NSK for butting rail specification.

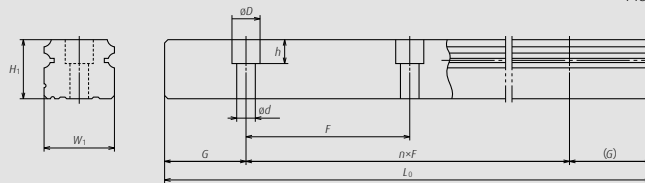

Unit: mm

Rail				Basic load rating								Weight	
Pitch F	Mounting bolt hole d×D×h	G (reference)	Max. length L _{0max} (for stainless)	Dynamic		Static C ₀ (N)	M _{Ro}	Static moment (N·m)				Ball slide (kg)	Rail (kg/m)
				[50km] C ₅₀ (N)	[100km] C ₁₀₀ (N)			M _{Po}		M _{Yo}			
								(One slide)	(Two slides)	(One slide)	(Two slides)		
60	*3.5×6×4.5 4.5×7.5×5.3	20.0	2,920 (1,700)	7,250	5,750	9,100	45.5	24.5	196	20.5	165	0.14	1.4
				11,200	8,850	16,900	84.5	77	470	64.5	395		
60	6×9.5×8.5	20.0	3,960 (3,500)	10,600	8,400	13,400	91.5	46.5	330	39	279	0.19	2.3
				15,600	12,400	23,500	160	133	755	111	630	0.28	
60	7×11×9	20.0	3,960 (3,500)	17,700	14,000	20,800	164	91	655	76	550	0.34	3.1
				26,100	20,700	36,500	286	258	1,470	217	1,230	0.51	
80	7×11×9	20.0	4,000 (3,500)	24,700	19,600	29,600	282	139	1,080	116	905	0.58	4.8
				38,000	30,000	55,000	520	435	2,650	365	2,220	0.85	
80	9×14×12	20.0	4,000 (3,500)	34,500	27,300	40,000	465	220	1,670	185	1,400	0.86	7.0
				52,500	42,000	74,500	865	695	4,000	580	3,350	1.3	

2) The basic load rating complies with ISO standard. (ISO14728-1 and ISO14728-2)

C₅₀: the basic dynamic load rating for 50 km rating fatigue life, C₁₀₀: the basic dynamic load rating for 100 km rating fatigue life;

* Standard rail mounting bolt hole for NS15 is specified as hole for M3 (3.5 x 6 x 4.5).

Please contact NSK to request a different hole for M4 (4.5 x 7.5 x 5.3).

Specifications

NS-JM (Medium-load type/short, square low-profile type)

NS-EM (High-load type/standard, square low-profile type)

(1) Reference number for assembly

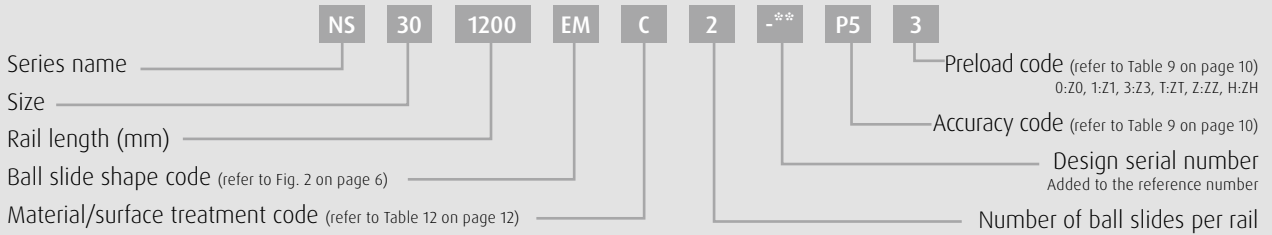

Assembly (Preloaded assembly, random-matching type)

Front view of EM and JM types

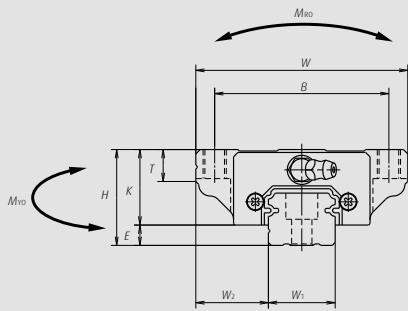

Side view of EM type

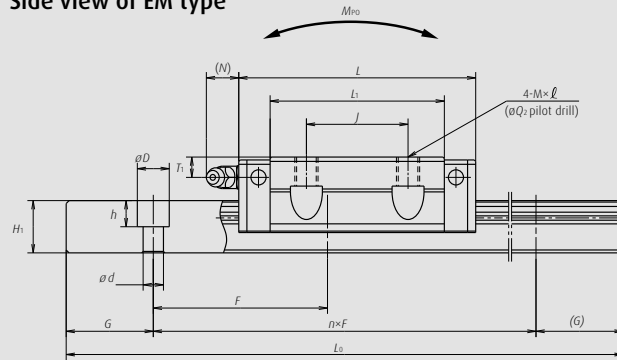

Side view of JM type

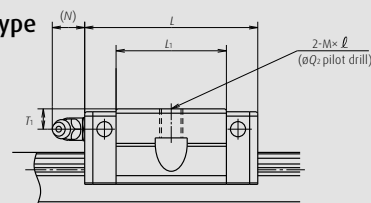

Model No.	Assembly					Ball slide											
	Height H	E	W ₂	Width W	Length L	Mounting hole				Grease fitting				Width W ₁	Height H ₁		
						B	J	M×Pitch×l	Q ₂	L ₁	K	T	Hole size			T ₁	N
NS15JM NS15EM	24	4.6	18.5	52	40.4 56.8	41	— 26	M5×0.8×7	4.4	23.6 40	19.4	8	ø3	6	3	15	12.5
NS20JM NS20EM	28	6	19.5	59	47.2 65.2	49	— 32	M6×1×9 (M6×1×9.5)	5.3	30 48	22	10	M6×0.75	5.5	11	20	15.5
NS25JM NS25EM	33	7	25	73	59.6 81.6	60	— 35	M8×1.25×10 (M8×1.25×11.5)	6.8	38 60	26	11 (12)	M6×0.75	7	11	23	18
NS30JM NS30EM	42	9	31	90	67.4 96.4	72	— 40	M10×1.5×12 (M10×1.5×14.5)	8.6	42 71	33	11 (15)	M6×0.75	8	11	28	23
NS35JM NS35EM	48	10.5	33	100	77 108	82	— 50	M10×1.5×13 (M10×1.5×14.5)	8.6	49 80	37.5	12 (15)	M6×0.75	8.5	11	34	27.5

Notes: 1) External appearance of stainless steel ball slides differs from those of carbon steel ball slides.

2) Parenthesized dimensions are for items made of stainless steel.

(2) Reference number for random-matching type

Ball Slide

Random-matching ball slide series code

NAS: NS Series random-matching ball slide

Size

Ball slide shape code
(refer to Fig. 2 on page 6)

NAS 30 EM S Z -K

Option code
-K: Equipped with NSK K1
-F: Fluoride low temperature chrome plating + AS2 grease
-F50: Fluoride low temperature chrome plating + LG2 grease
Preload code
No code: Fine clearance, Z: Slight preload, H: Medium preload
Material code
No code: Special high carbon steel (NSK standard),
S: Stainless steel

EM and JM types

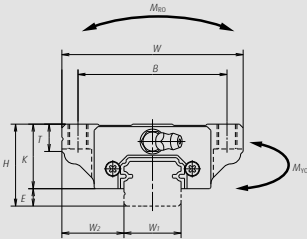

EM type

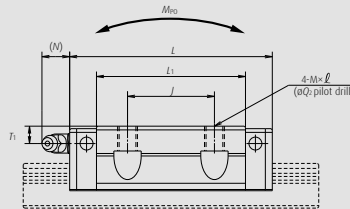

JM type

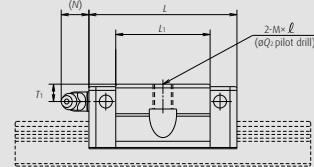

Rail

Random-matching rail series code

N1S: NS Series random-matching rail

Size

Rail length (mm)

Rail shape code: L

L: Standard, T: The rail mounting bolt hole M4 for NS1S

Material/surface treatment code (refer to Table 12 on page 12)

N1S 30 1200 L C N - PC Z**

Preload code
(refer to Table 9 on page 10)
T: Fine clearance,
Z: Slight preload
(common rail for slight or medium preload)
Accuracy code
PH: High precision grade random-matching type
PC: Normal grade random-matching type
Design serial number
Added to the reference number
Butting rail specification*
N: Non-butting; L: Butting specification
*Please consult with NSK for butting rail specification.

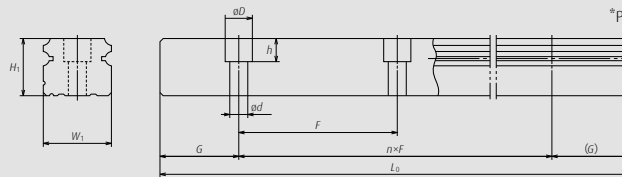

Unit: mm

Rail				Basic load rating								Weight	
Pitch F	Mounting bolt hole d×D×h	G (reference)	Max. length L _{0max} (for stainless)	Dynamic		Static C ₀ (N)	M _{RO}	Static moment (N·m)				Ball slide (kg)	Rail (kg/m)
				[50km] C ₅₀ (N)	[100km] C ₁₀₀ (N)			M _{P0} (One slide) (Two slides)		M _{V0} (One slide) (Two slides)			
60	*3.5×6×4.5 4.5×7.5×5.3	20.0	2,920 (1,700)	7,250	5,750	9,100	45.5	24.5	196	20.5	165	0.17	1.4
				11,200	8,850	16,900	84.5	77	470	64.5	395	0.26	
60	6×9.5×8.5	20.0	3,960 (3,500)	10,600	8,400	13,400	91.5	46.5	330	39	279	0.24	2.3
				15,600	12,400	23,500	160	133	755	111	630	0.35	
60	7×11×9	20.0	3,960 (3,500)	17,700	14,000	20,800	164	91	655	76	550	0.44	3.1
				26,100	20,700	36,500	286	258	1,470	217	1,230	0.66	
80	7×11×9	20.0	4,000 (3,500)	24,700	19,600	29,600	282	139	1,080	116	905	0.76	4.8
				38,000	30,000	55,000	520	435	2,650	365	2,220	1.2	
80	9×14×12	20.0	4,000 (3,500)	34,500	27,300	40,000	465	220	1,670	185	1,400	1.2	7
				52,500	42,000	74,500	865	695	4,000	580	3,350	1.7	

3) The basic load rating complies with ISO standard. (ISO14728-1 and ISO14728-2)

C₅₀: the basic dynamic load rating for 50 km rating fatigue life, C₁₀₀: the basic dynamic load rating for 100 km rating fatigue life,

*) Standard rail mounting bolt hole for NS1S is specified as hole for M3 (3.5 x 6 x 4.5). Please contact NSK to request a different hole for M4 (4.5 x 7.5 x 5.3).



NSK Sales Offices – Europe, Middle East and Africa

UK

NSK UK Ltd.
Northern Road, Newark
Nottinghamshire NG24 2JF
Tel. +44 (0) 1636 605123
Fax +44 (0) 1636 643276
info-uk@nsk.com

France & Benelux

NSK France S.A.S.
Quartier de l'Europe
2, rue Georges Guynemer
78283 Guyancourt Cedex
Tel. +33 (0) 1 30573939
Fax +33 (0) 1 30570001
info-fr@nsk.com

Germany, Austria, Switzerland, Nordic

NSK Deutschland GmbH
Harkortstraße 15
40880 Ratingen
Tel. +49 (0) 2102 4810
Fax +49 (0) 2102 4812290
info-de@nsk.com

Italy

NSK Italia S.p.A.
Via Garibaldi, 215
20024 Garbagnate
Milanese (MI)
Tel. +39 02 995 191
Fax +39 02 990 25 778
info-it@nsk.com

Middle East

NSK Bearings Gulf Trading Co.
JAFZA View 19, Floor 24 Office 2/3
Jebel Ali Downtown,
PO Box 262163
Dubai, UAE
Tel. +971 (0) 4 804 8205
Fax +971 (0) 4 884 7227
info-me@nsk.com

Poland & CEE

NSK Polska Sp. z o.o.
Warsaw Branch
Ul. Migdałowa 4/73
02-796 Warszawa
Tel. +48 22 645 15 25
Fax +48 22 645 15 29
info-pl@nsk.com

Russia

NSK Polska Sp. z o.o.
Russian Branch
Office I 703, Bldg 29,
18th Line of Vasilievskiy Ostrov,
Saint-Petersburg, 199178
Tel. +7 812 3325071
Fax +7 812 3325072
info-ru@nsk.com

South Africa

NSK South Africa (Pty) Ltd.
25 Galaxy Avenue
Linbro Business Park
Sandton 2146
Tel. +27 (011) 458 3600
Fax +27 (011) 458 3608
nsk-sa@nsk.com

Spain

NSK Spain, S.A.
C/ Tarragona, 161 Cuerdo Bajo
2^a Planta, 08014 Barcelona
Tel. +34 93 2892763
Fax +34 93 4335776
info-es@nsk.com

Turkey

NSK Rulmanları Orta Doğu Tic. Ltd. Şti
19 Mayıs Mah. Atatürk Cad.
Ulya Engin İş Merkezi No: 68/3 Kat. 6
P.K.: 34736 - Kozyatağı - İstanbul
Tel. +90 216 4777111
Fax +90 216 4777174
turkey@nsk.com

Please also visit our website: www.nskeurope.com
Global NSK: www.nsk.com

